

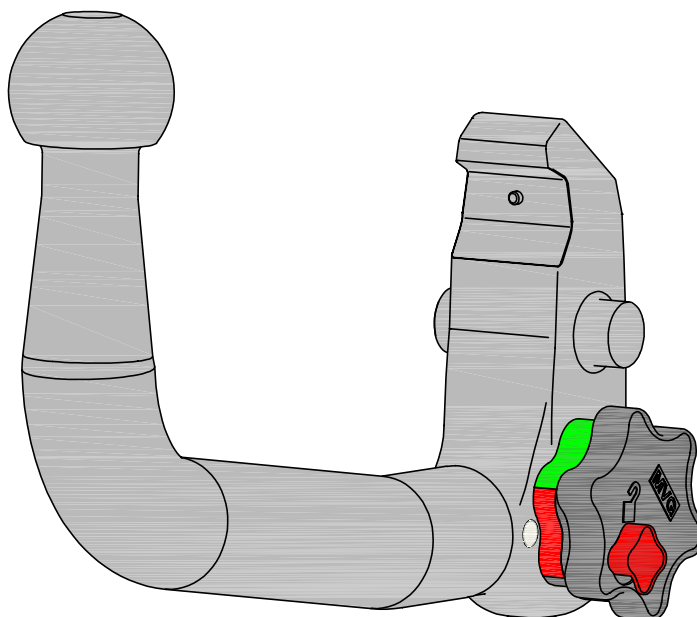

Die Anhängerkupplung.

Anhängerkupplungen
und Elektrosätze
direkt vom Hersteller



MVG-System: 2040

D Bedienungsanleitung

GB Operating Instructions

F Instructions d'emploi

I Istruzioni d'uso

E Instrucciones de manejo

CZ Návod k obsluze

NL Gebruikshandleiding

S Bruksanvisning

MVG-Metallverarbeitungsgesellschaft mbH

An der Wasserwiese 1
52249 Eschweiler
Deutschland

Tel.: +49 (0) 2403 7902-60
Fax: +49 (0) 2403 7902-99
E-Mail: info@mvg-ahk.de

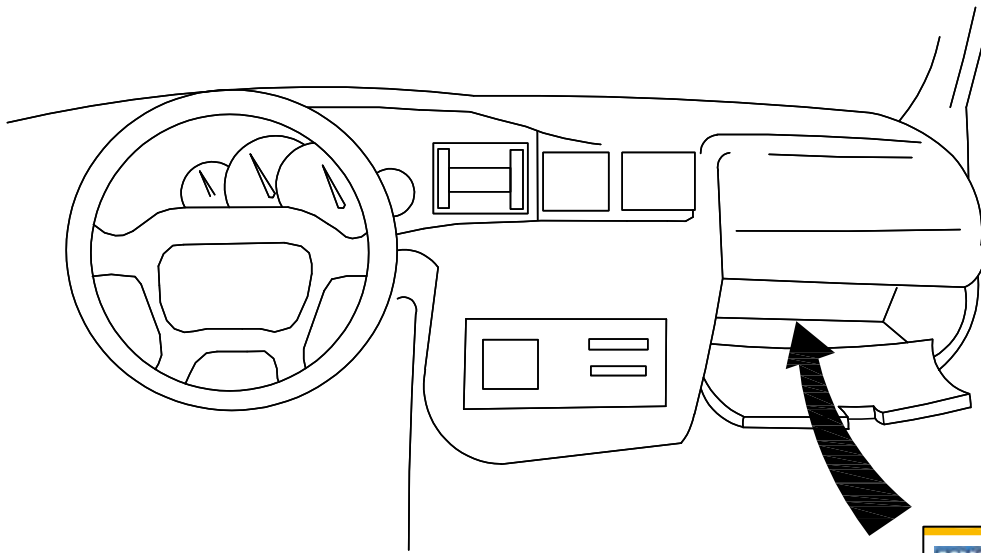

(D) Technische Änderungen vorbehalten
 (GB) technical changes reserved

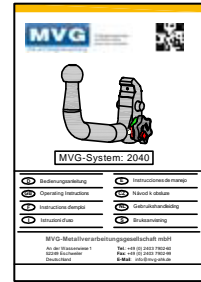

(D) siehe
 Bedienungsanleitung
 (GB) see operating
 instructions

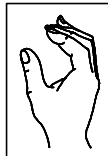

(D) Von Hand
 (GB) by hand

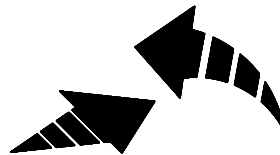

(D) Bewegungspfeil
 (GB) movement arrow

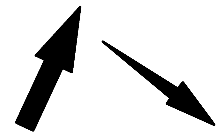

(D) Positionspfeil
 (GB) location arrow



(D) Achtung
 (GB) attention



CLEANER

(D) Reinigen
 (GB) make clean

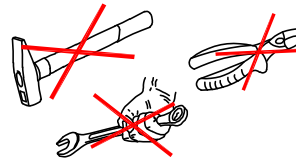

(D) Nicht bearbeiten
 (GB) do not edit

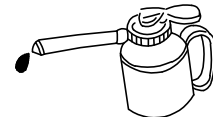

(D) Ölen
 (GB) oil

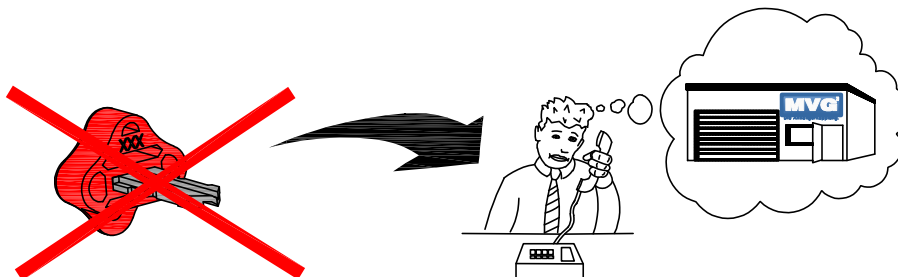
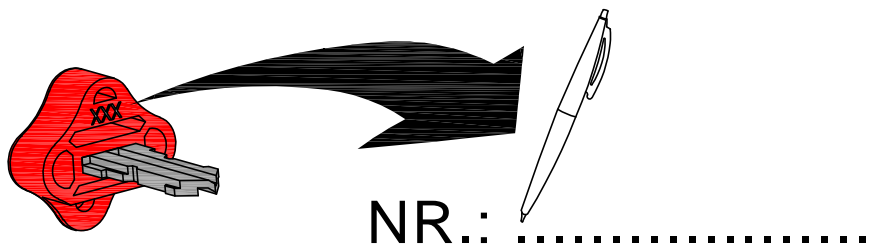

1		Kugelstange / ball rod
2		Verriegelungsbolzen / locking bolt
3		Handrad / hand wheel
4		Grüner Bereich / green area
5		Roter Bereich / red area
6		Schlüssel / key
7		Schutzkappe / protective cap
8		Schutztasche / protective bag
9		Bedienungsanleitung / Operating Instructions

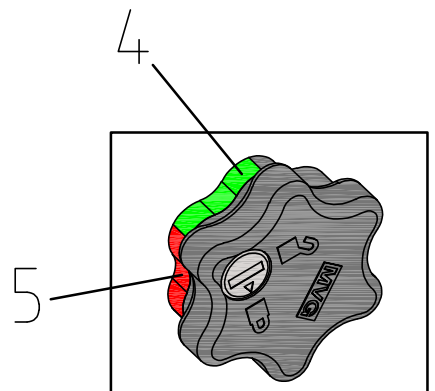
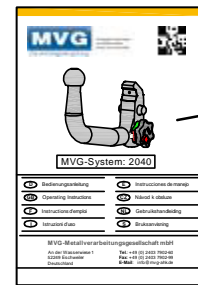
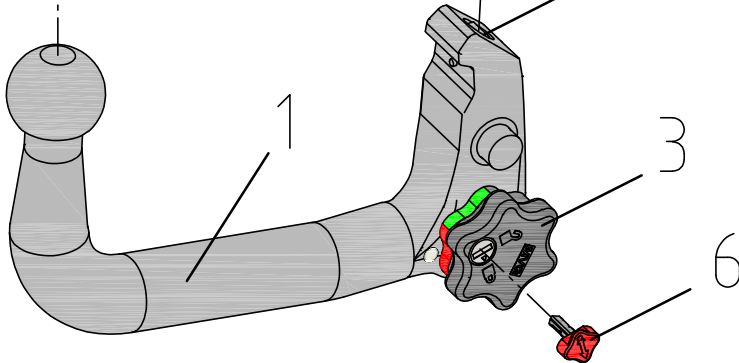
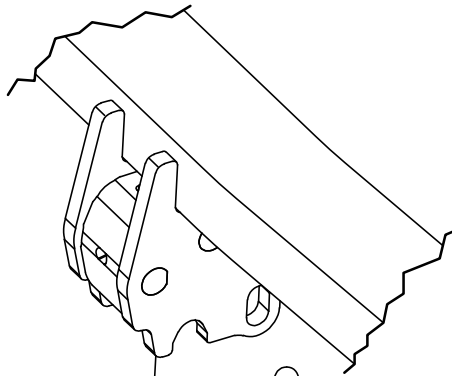
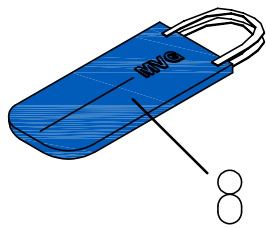

"in"

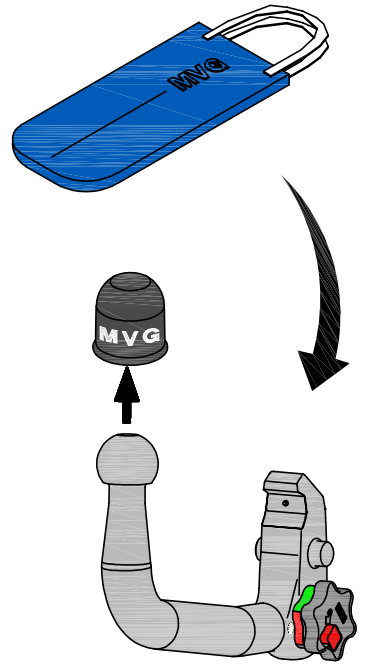
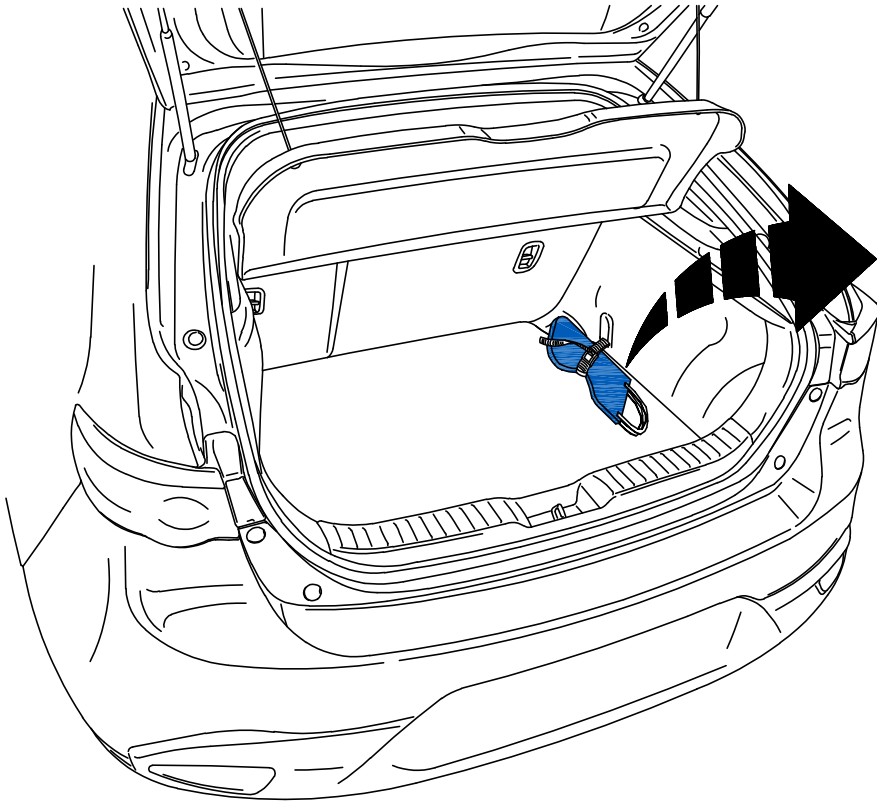

1

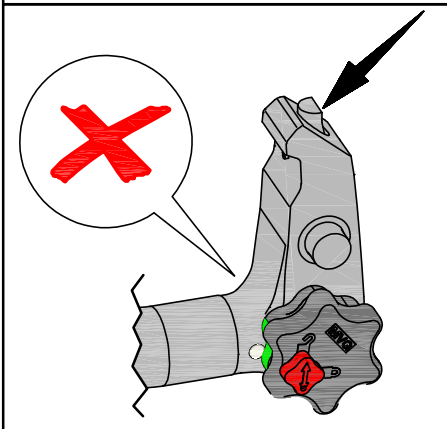
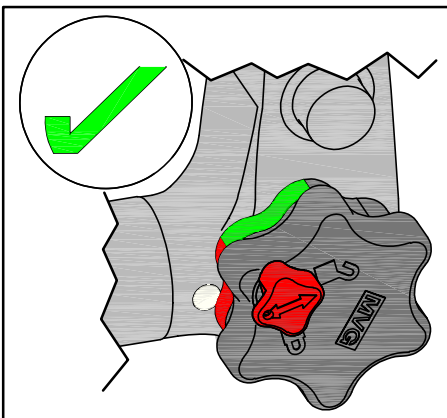

2

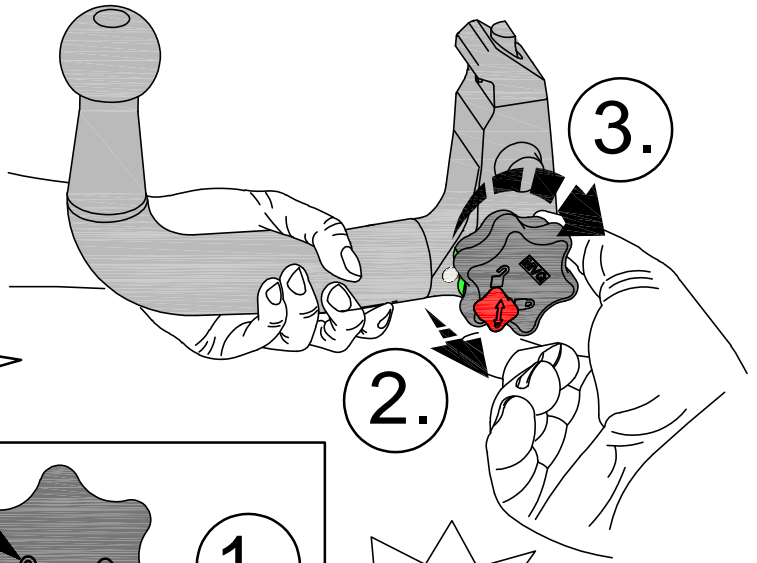
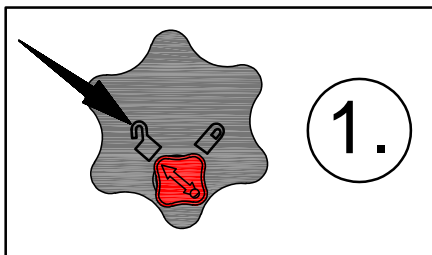
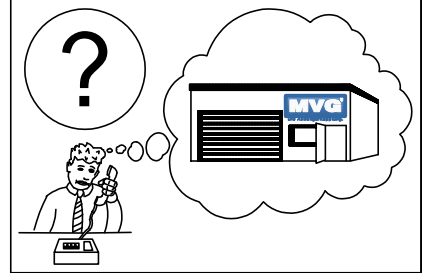

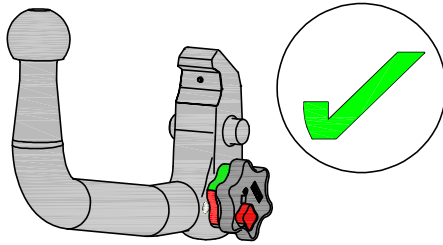

1.

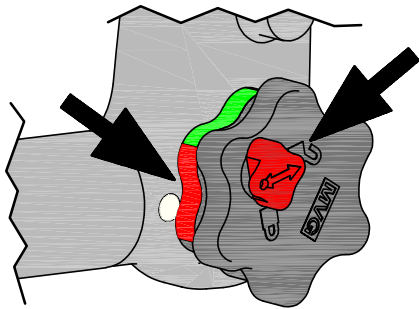

2.

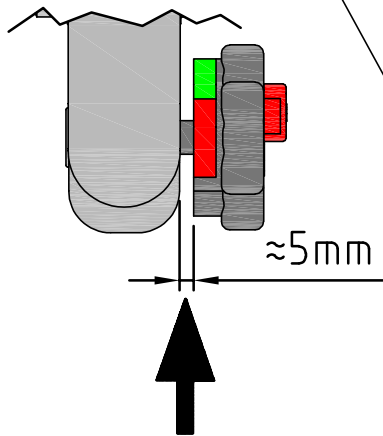

3.

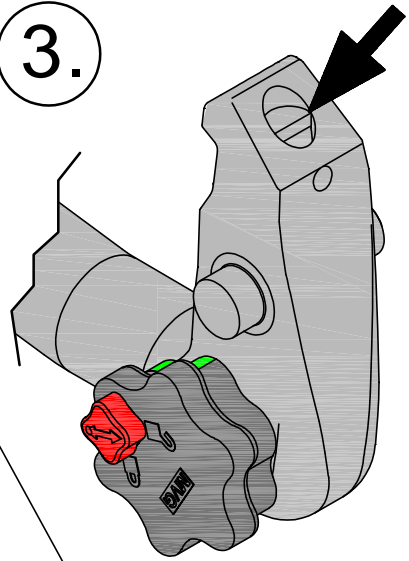

3

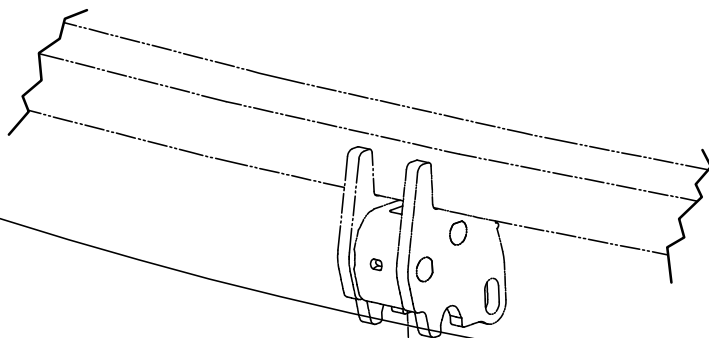
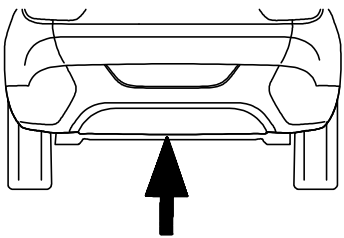

2.

1.

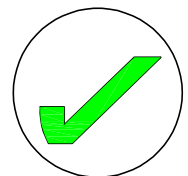
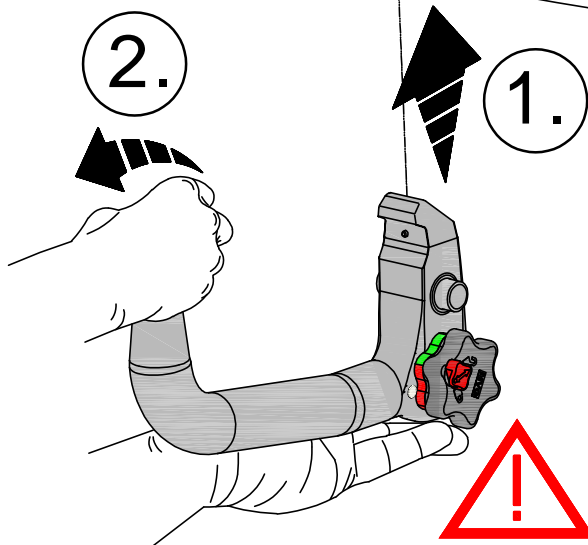
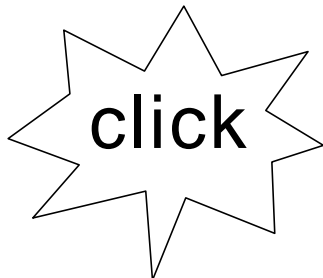

4

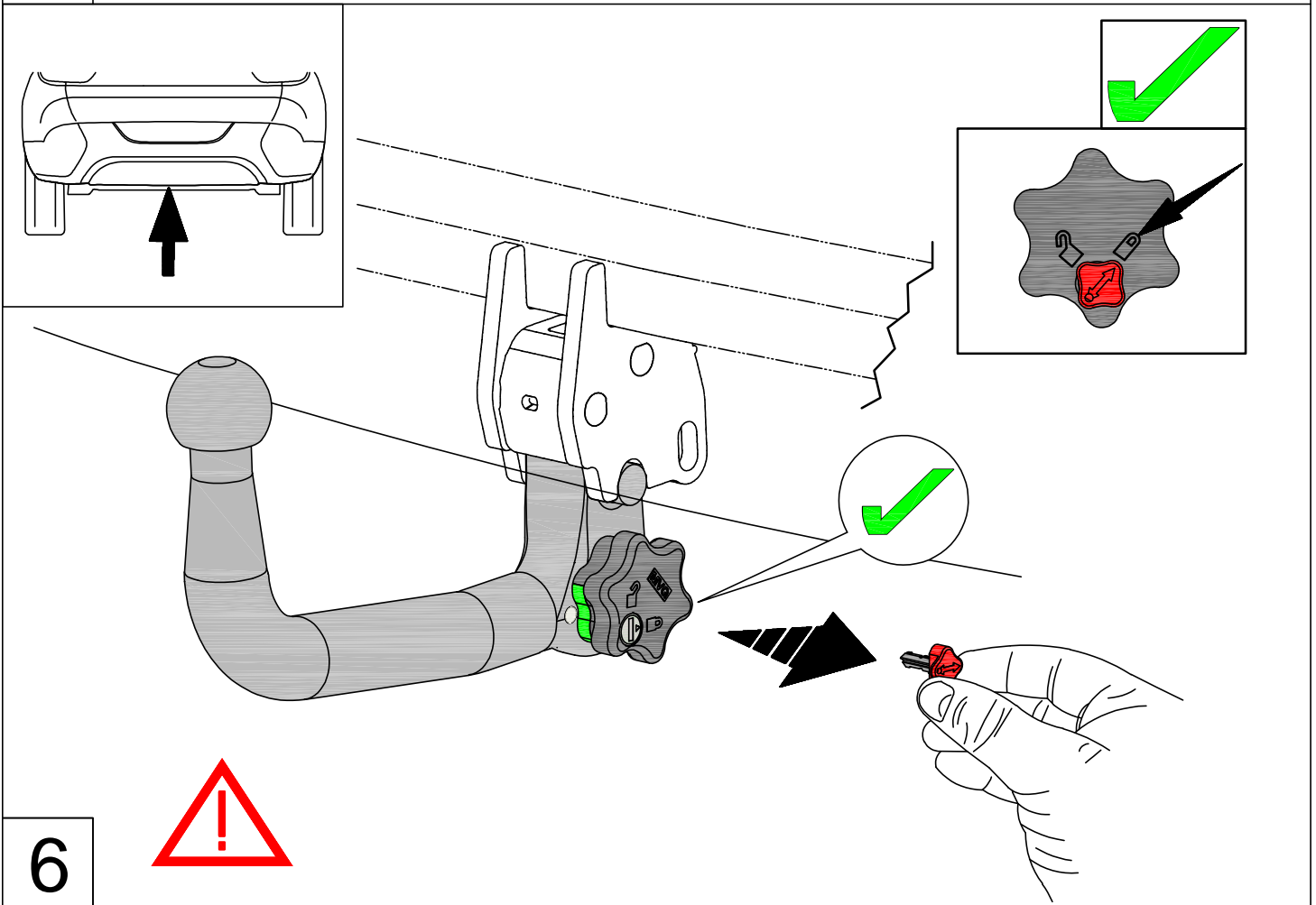
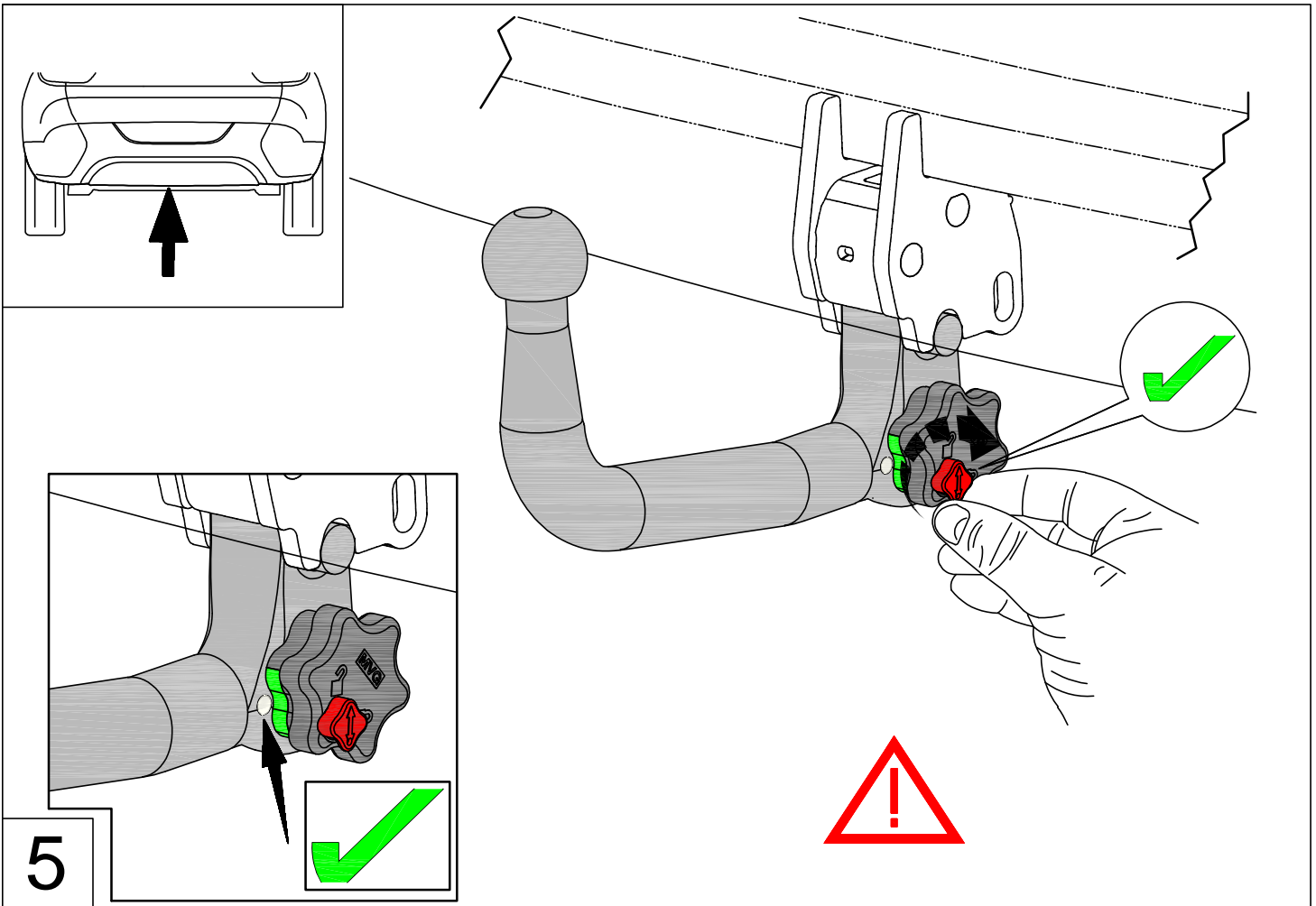

Sicherheitskontrolle / Safety Checks:

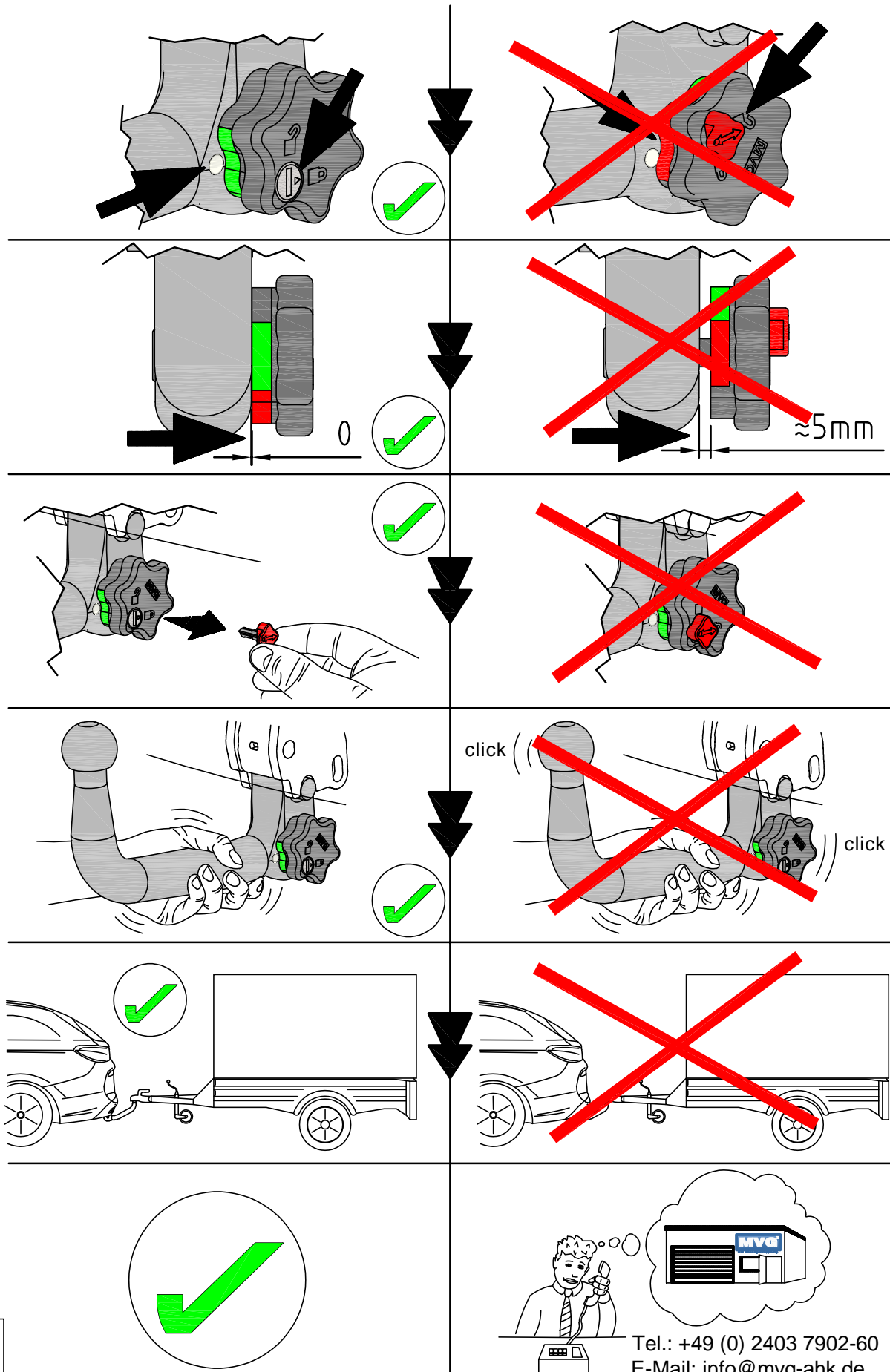

7

Tel.: +49 (0) 2403 7902-60
E-Mail: info@mvg-ahk.de

"out"

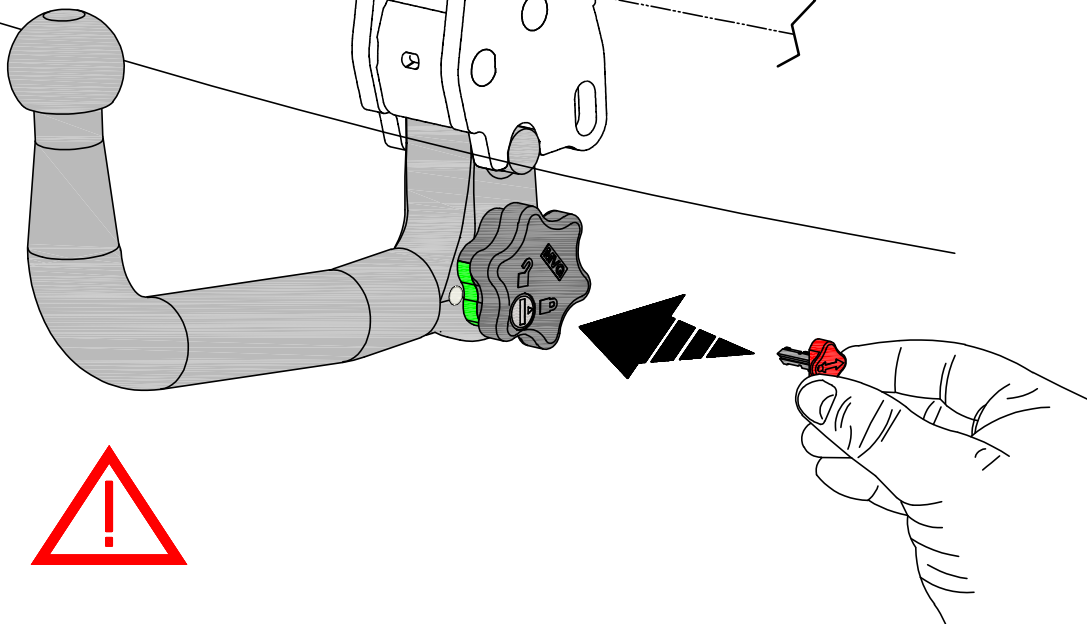
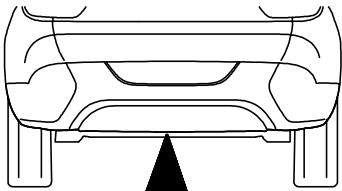

8

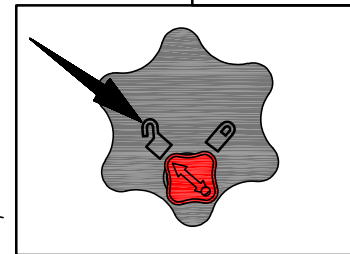
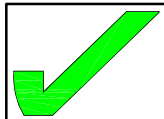
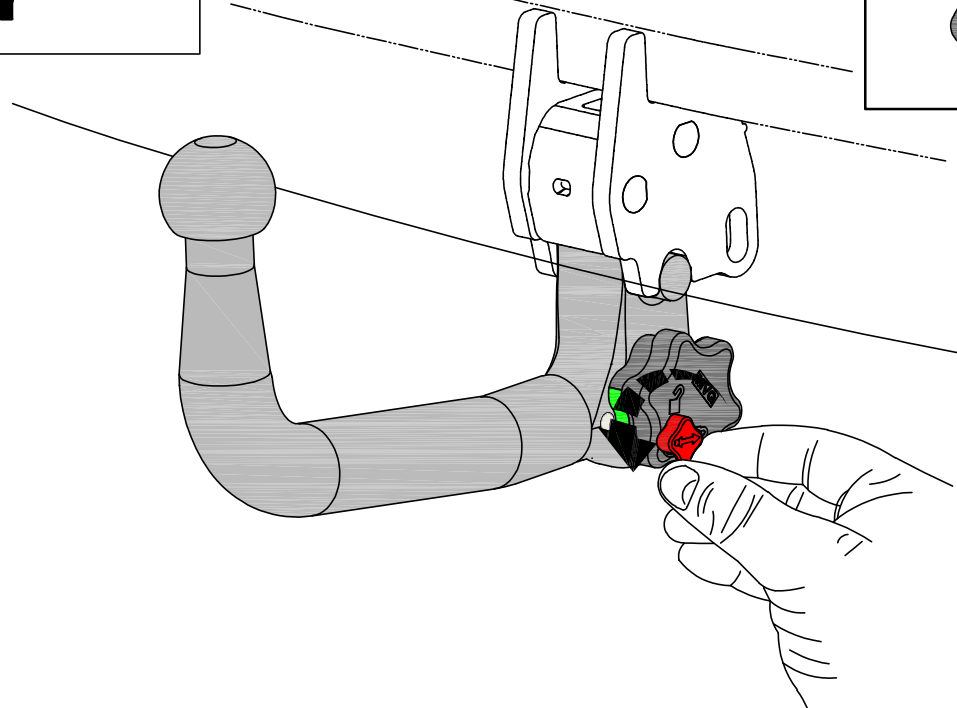
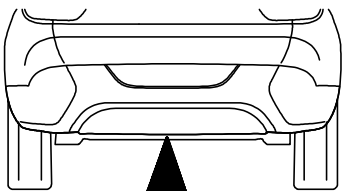

9

1.

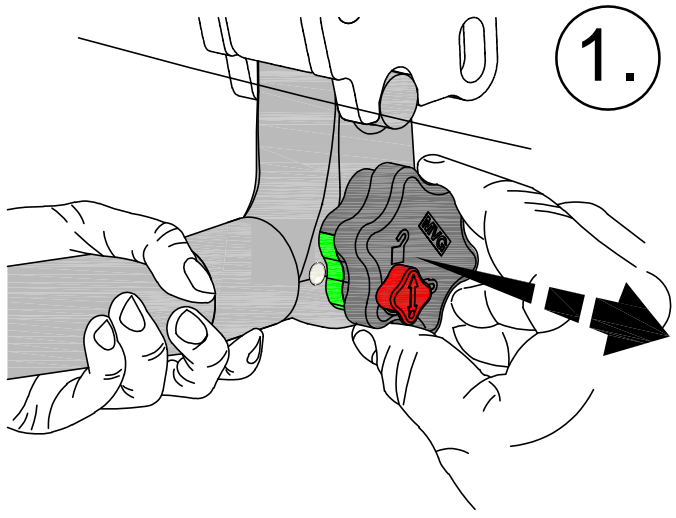

2.

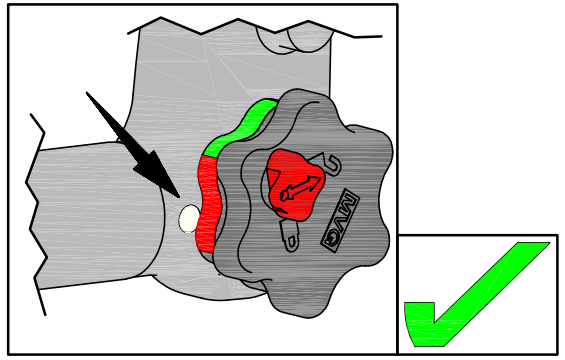
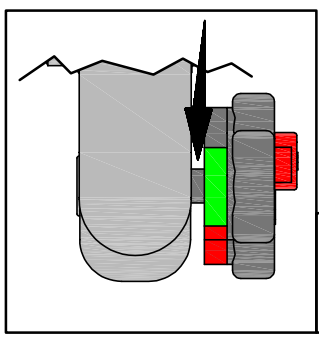
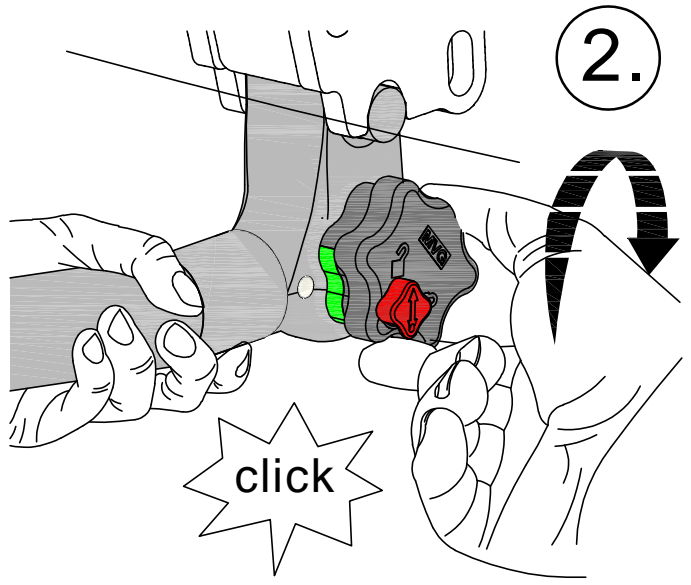

10

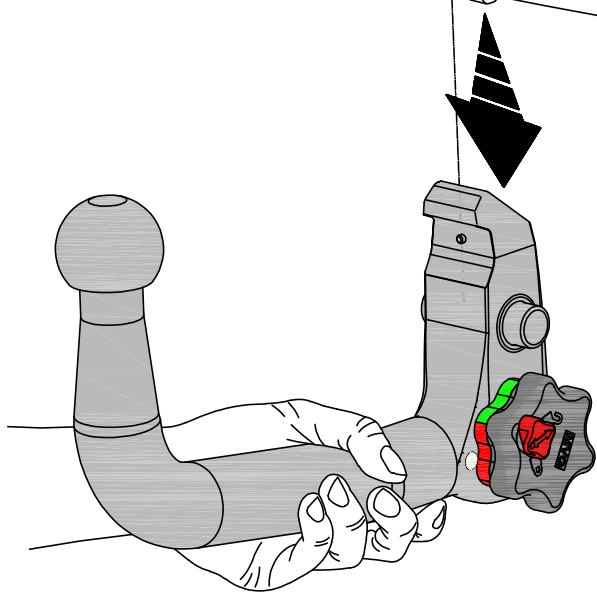
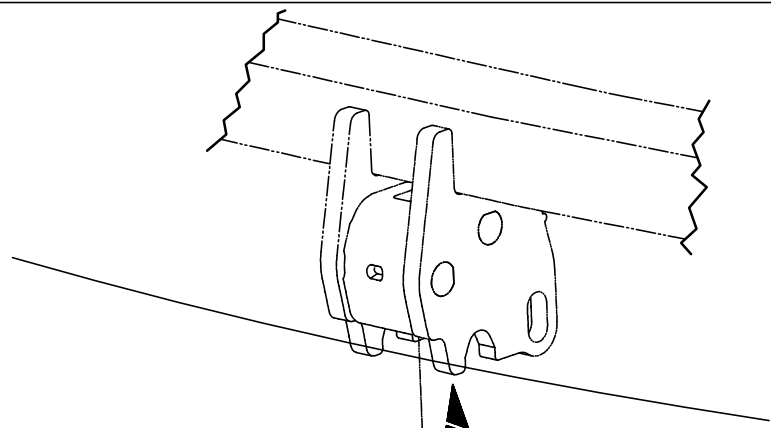
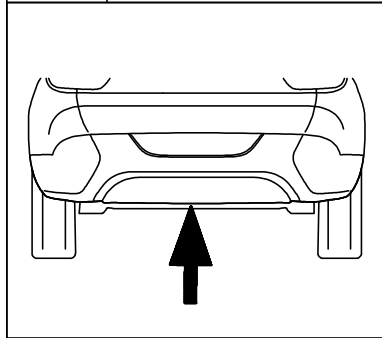

11

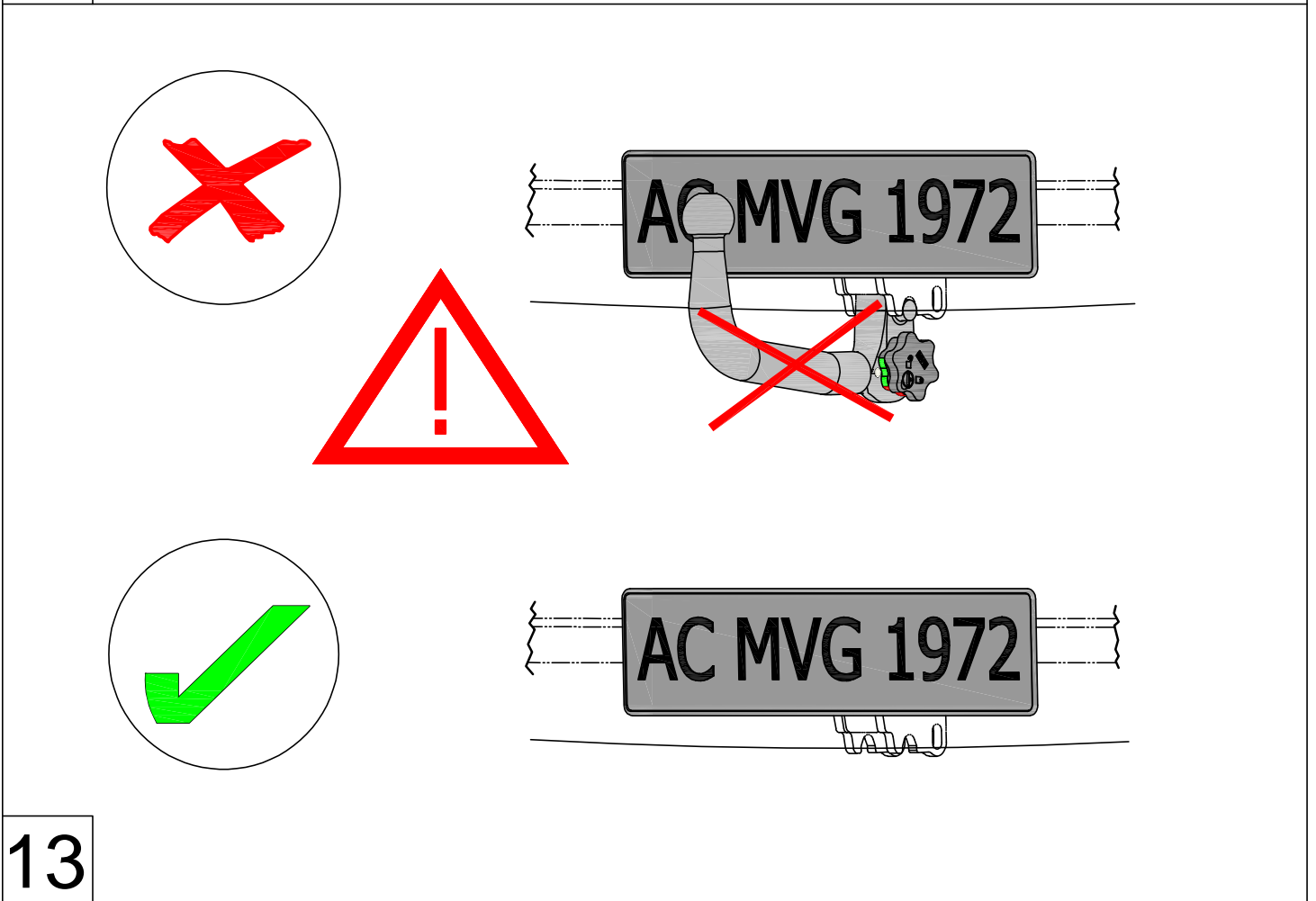
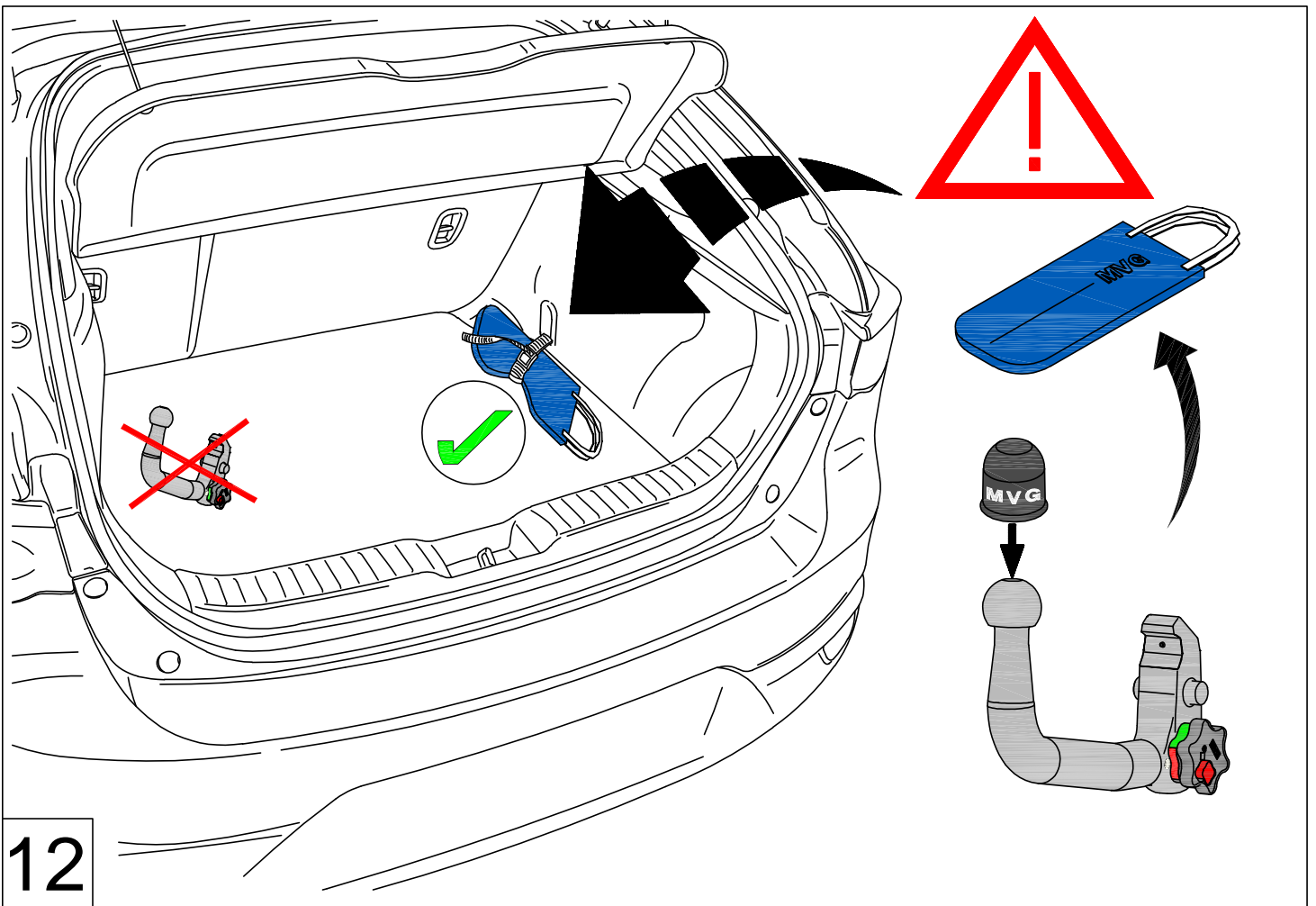

Bedienungshinweise / Operating instructions:

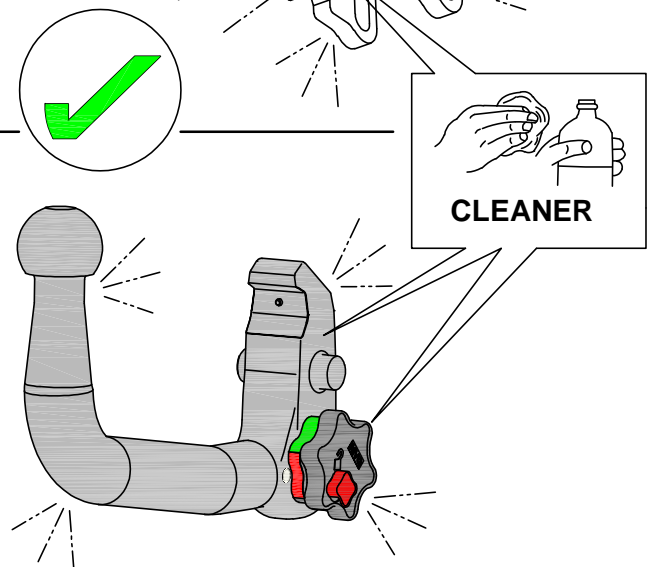
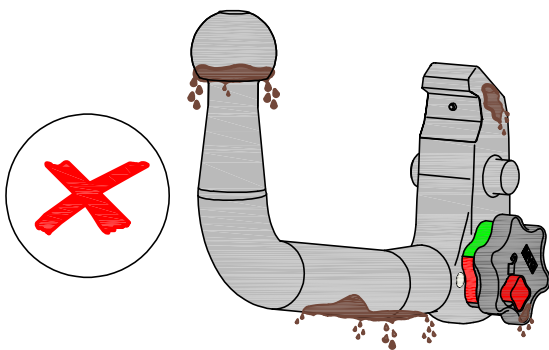
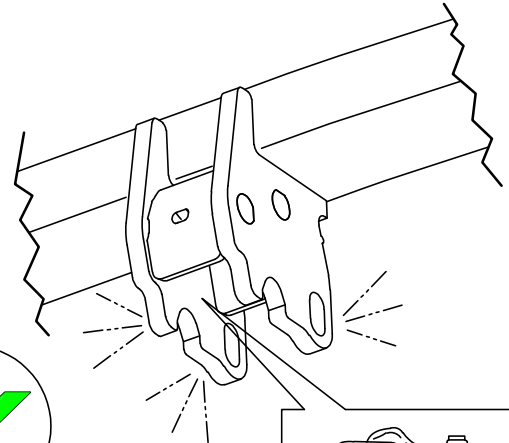
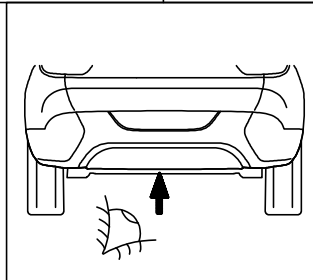
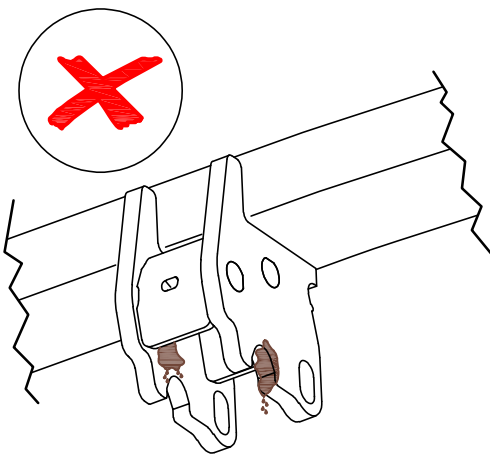
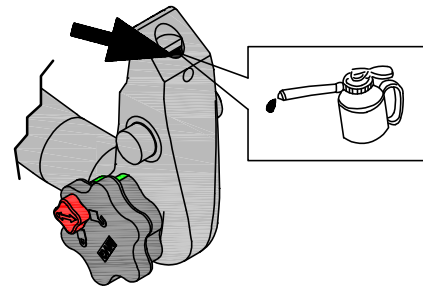
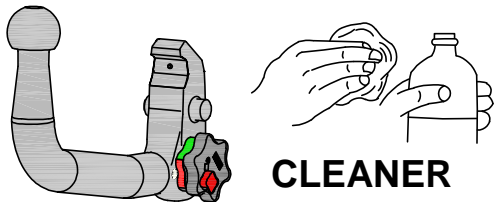
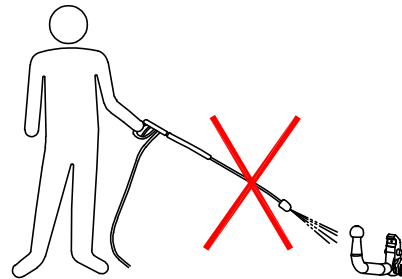
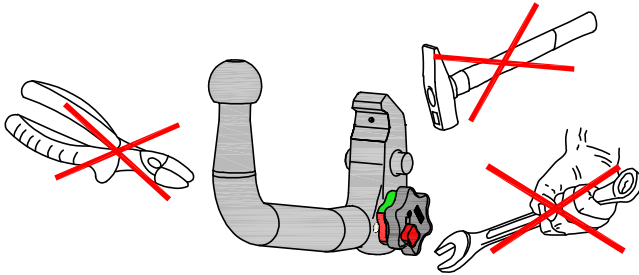
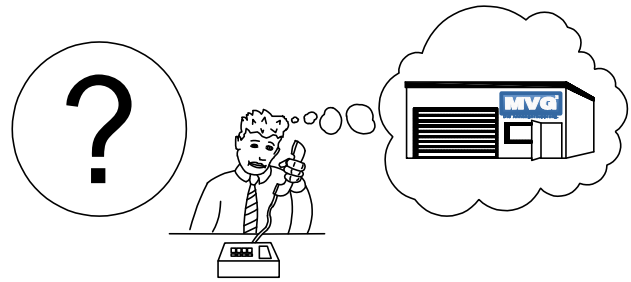
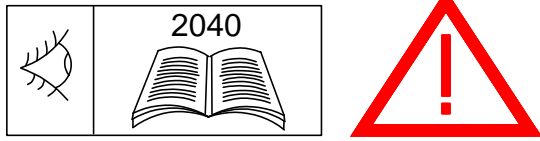

Bedienungshinweise / Operating instructions:

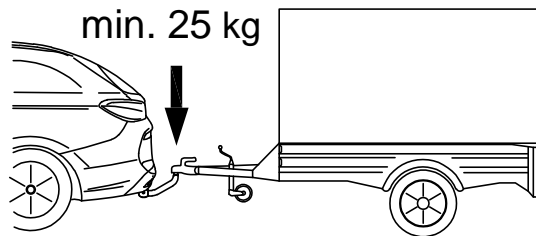
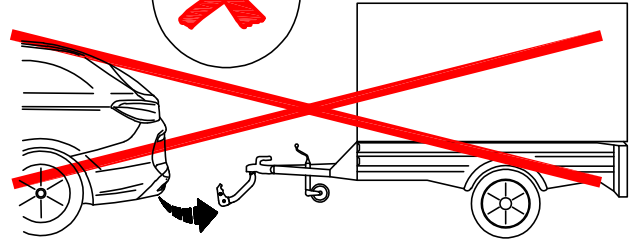
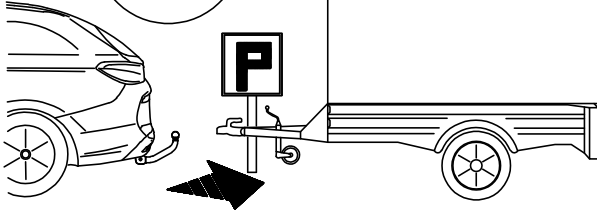
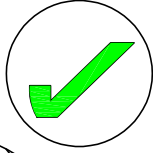
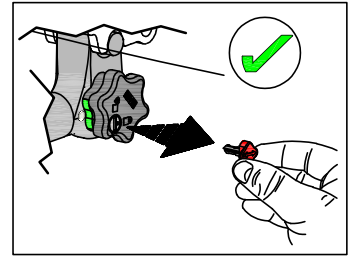
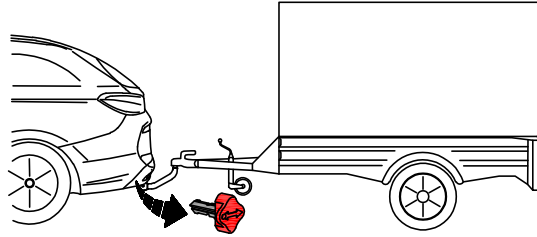

Die Bedienungsanleitung als Video finden Sie unter folgendem Link:

This instruction manual can be found as an illustrating video under the following link:

<https://mvg.li/2040>

Außerdem können Sie mit Ihrem Smartphone den Video-Link durch diesen QR-Code direkt scannen und das Video ansehen.

Furthermore, the link to the video can be scanned and watched via this QR code by the use of your smartphone.



www.mvg-ahk.de
www.mvg-ahk.at
www.mvg-ahk.ch
www.mvg-ahk.com