

Capacitive Touch Pad

Owner's Manual

General Operation

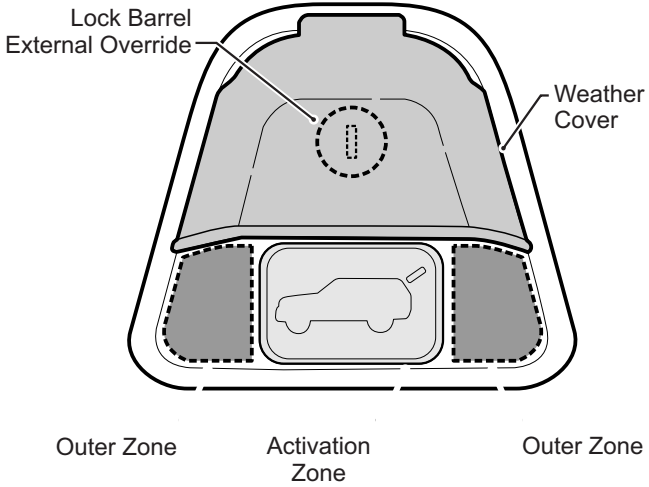

Initial Power up delay: 10 seconds

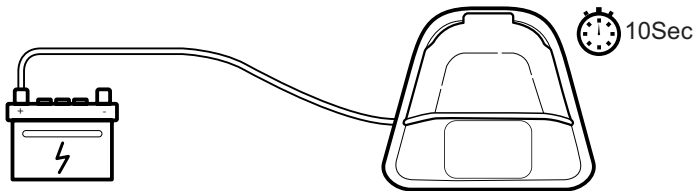



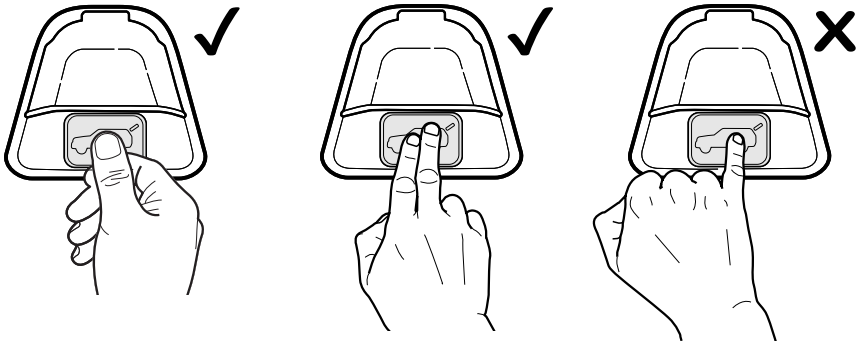









Preferred Activation Method:



General Operation

Touch Pad Active / Inactive Table

<i>Rear Window Status</i>	<i>Vehicle Lock Status</i>	<i>Touch Pad Status</i>
		
		
		
		

General Operation

Quick Guide: Unlock & Open

①

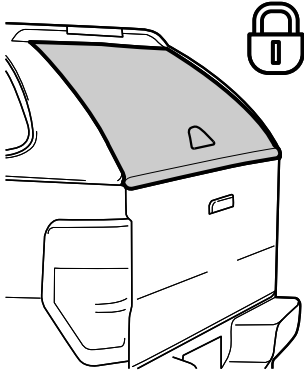

②

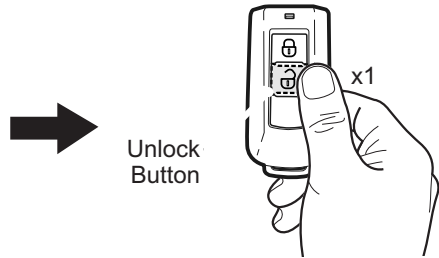

③

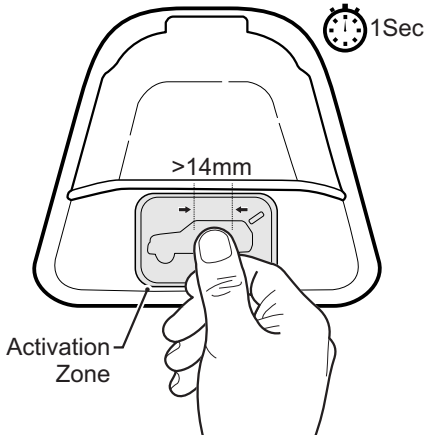

④

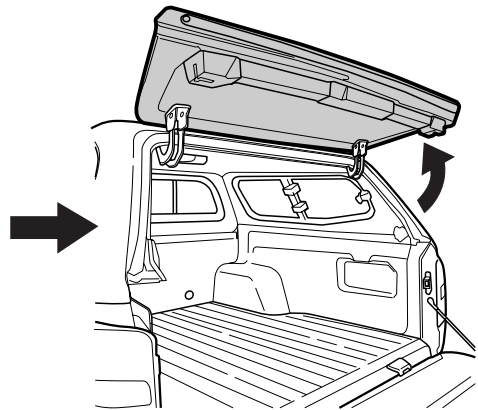

General Operation

Quick Guide: Close & Lock

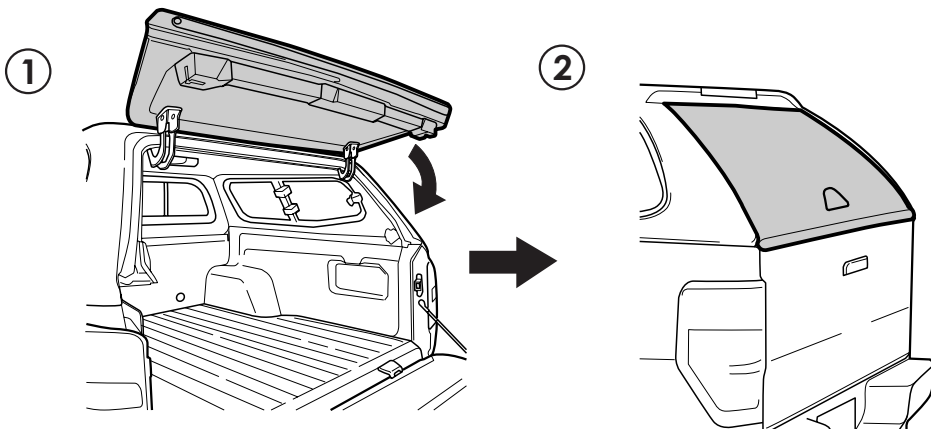

3

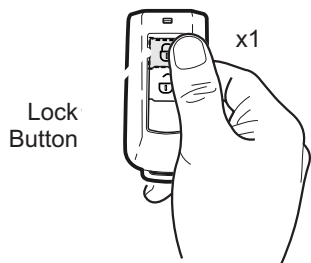

General Operation

External Manual Release:

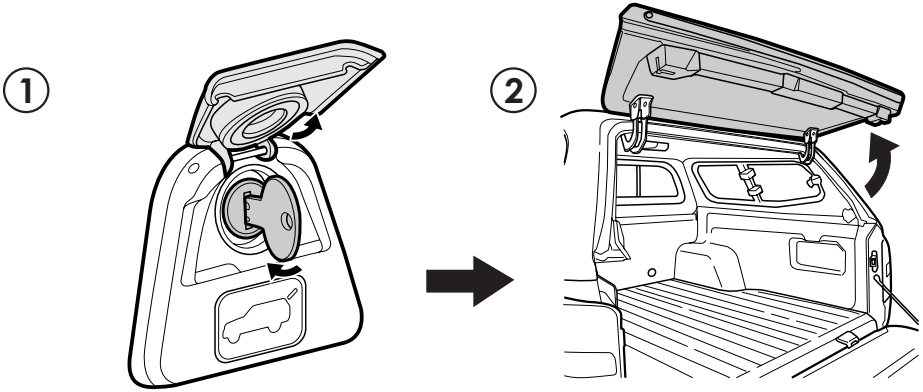

Internal Manual Release:

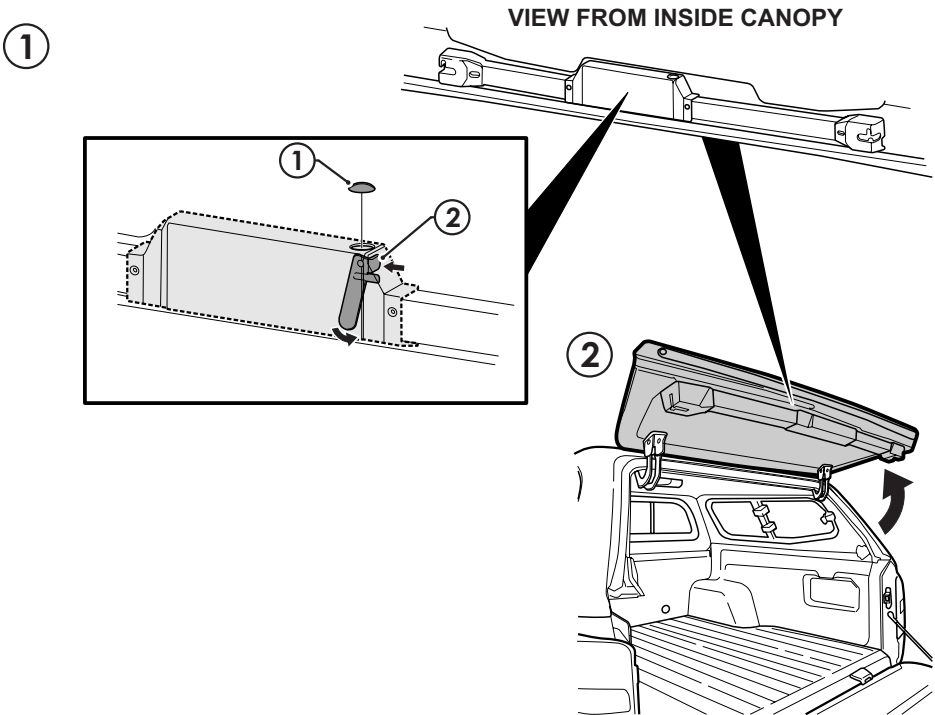

General Operation

Capacitive Touch Pad Override: Disable

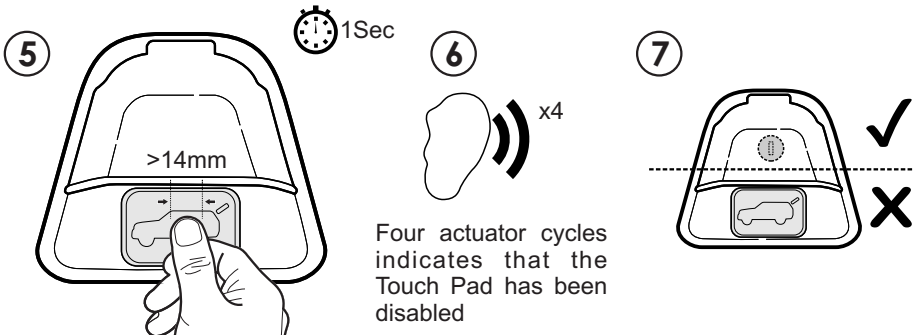
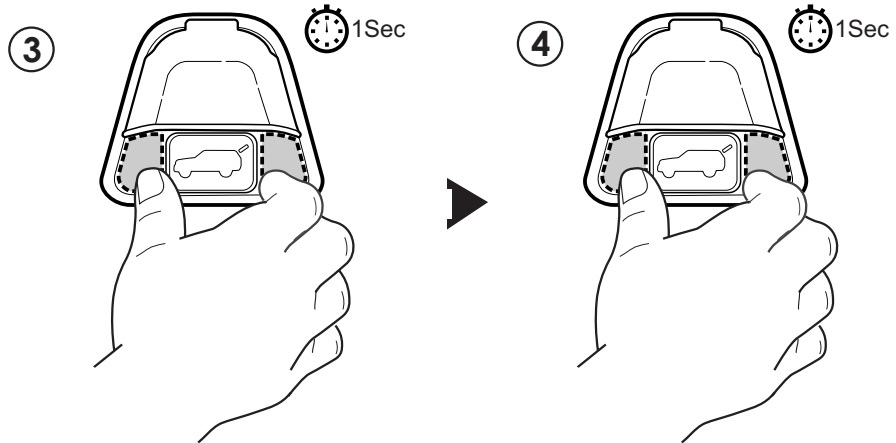
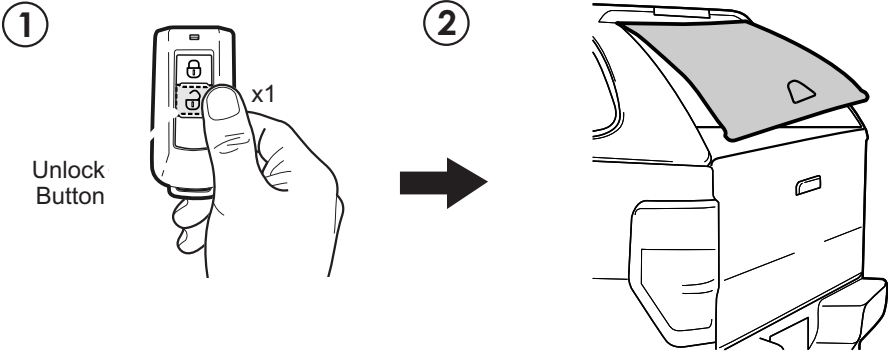

General Operation

Capacitive Touch Pad Override: Enable

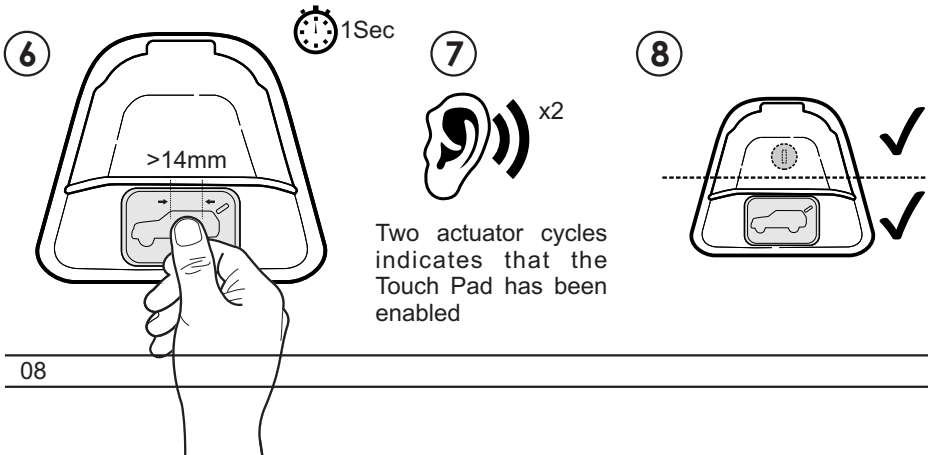
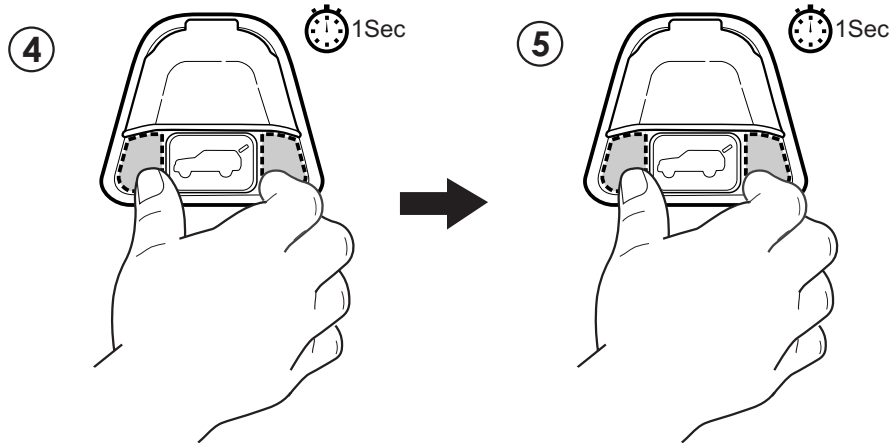
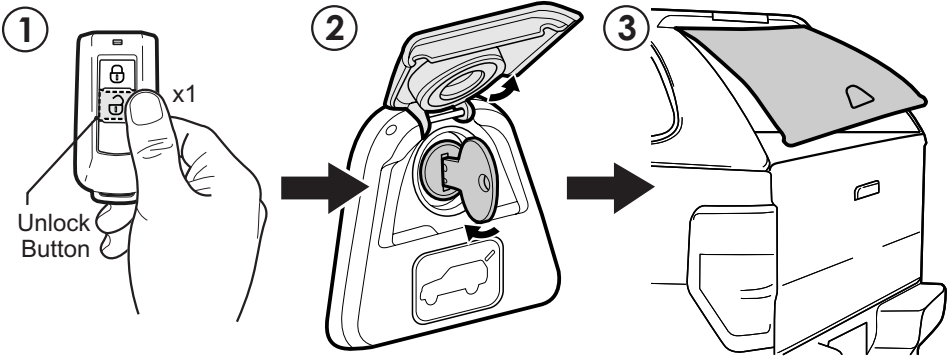

General Operation

Compatibility:

Border Control:

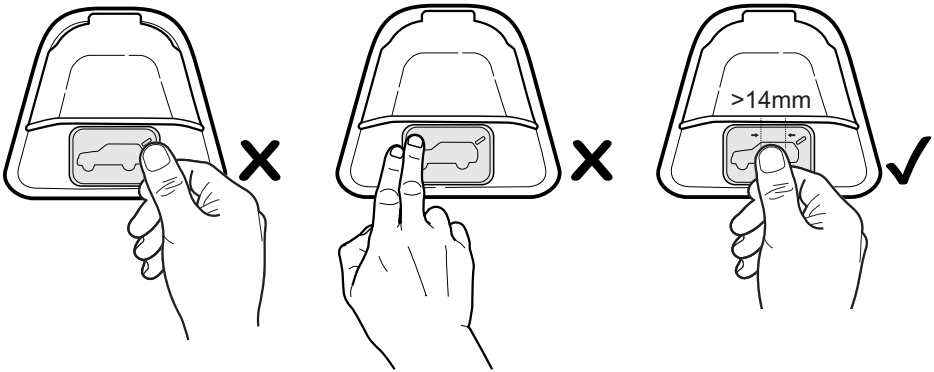

Gloves

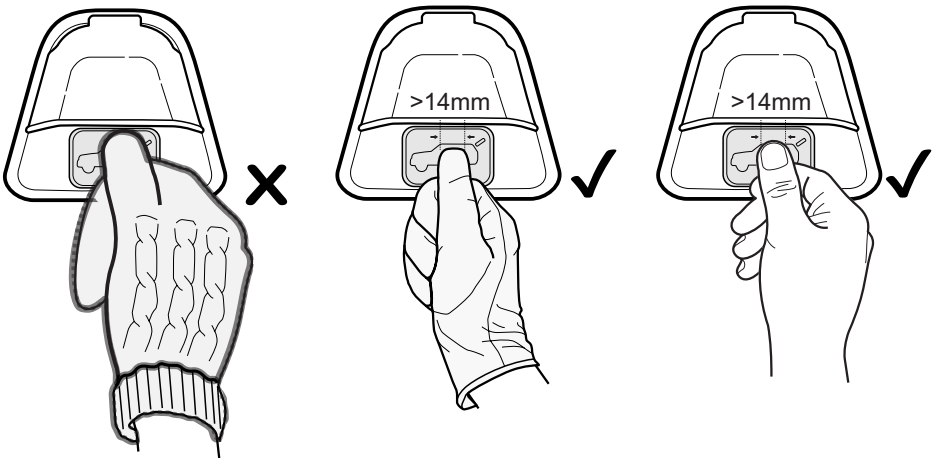

General Operation

Compatibility:

Ice & Snow:

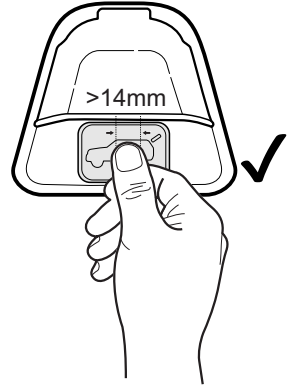
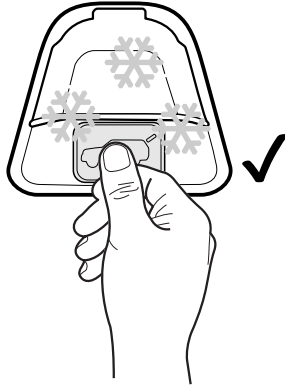
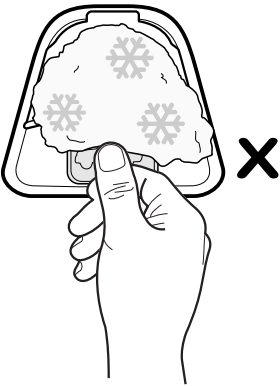
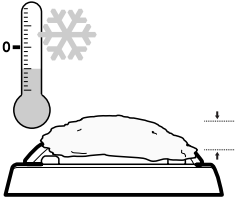

Rain & Wet:

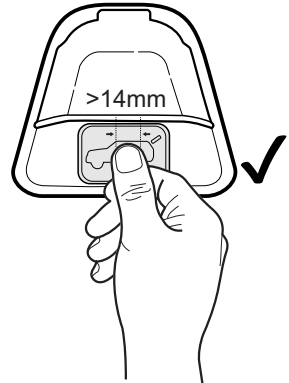
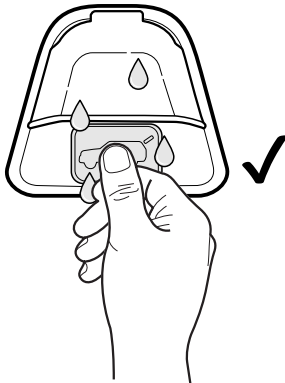
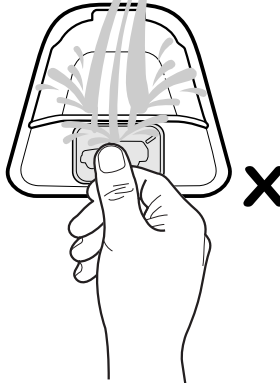
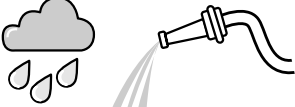

General Operation

Compatibility:

Dirt:

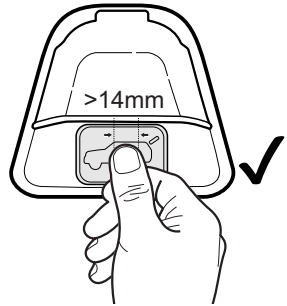
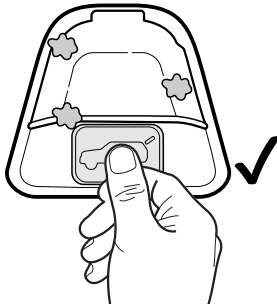
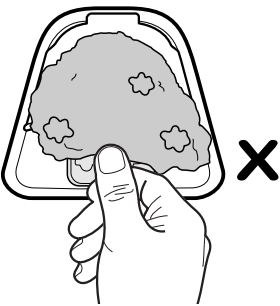
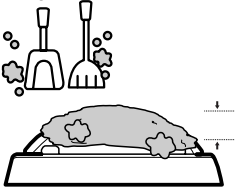

Cold &

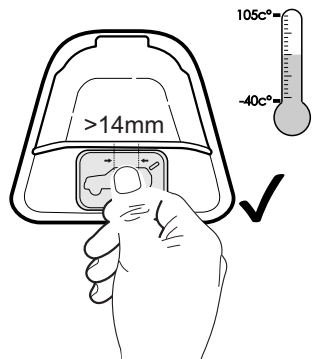
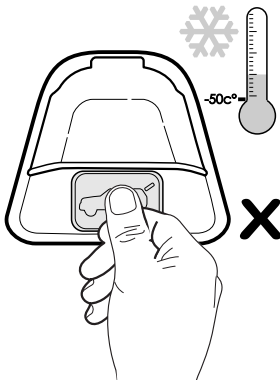
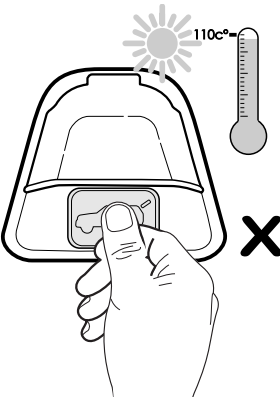

Immunity: The Capacitive Touch Pad has been configured to ignore un-intended triggers when exposed to the following conditions: Carwash, Direct Hose, Dripping Water, Wind, Dust, etc. however the immunity of the Touch Pad cannot be guaranteed in all user cases.

If the user wants to ensure the Capacitive Touch Pad remains inactive in all conditions then the user may lock the base program vehicle &/or deactivate the Capacitive Touch Pad by following the "disable function" instruction in this booklet.

© COPYRIGHT 2019

E. & O.E. This document is copyright and must not be used except as permitted below or under the Copyright Act 1968. You may reproduce and publish this document in whole or in part for you or your organisation's own Personal or internal compliance, educational or non-commercial purposes. You must not alter or amend this document in any way. You must not reproduce or publish this document for commercial gain without the prior written consent of the copyright owner.
